

# Data Sheet



Article number: 1080401121000

Description: Servocontroller ACU401-12-FA  
1,85 kW 4,2A 3x400V IP20

## Measures

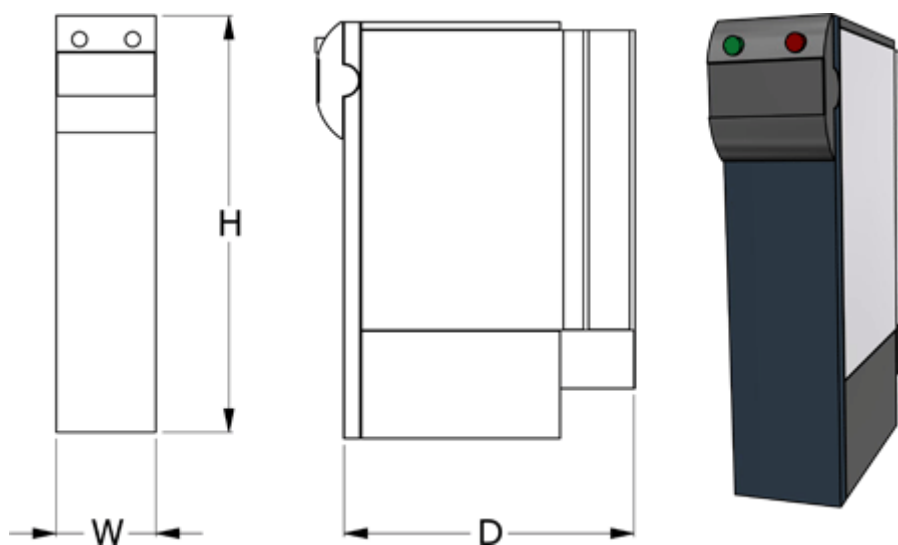

D = 175

H = 250

W = 60

Weight = 1.6